

1.72, Groundwater Hydrology  
 Prof. Charles Harvey  
**Lecture Packet #4: Continuity and Flow Nets**

**Equation of Continuity**

- Our equations of hydrogeology are a combination of
  - Conservation of mass
  - Some empirical law (Darcy's Law, Fick's Law)
- Develop a control volume, rectangular parallelepiped, REV (Representative Elementary Volume)

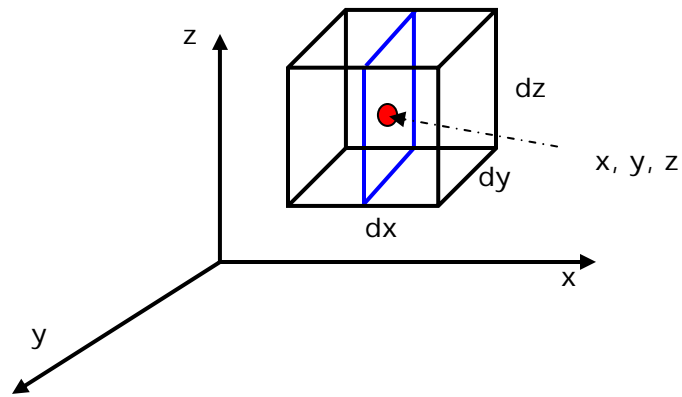

mass inflow rate – mass outflow rate = change in mass storage

$q_x$  = specific discharge in x-direction (volume flux per area)  
 at a point  $x, y, z$   $L^3/L^2 \cdot T$

Consider mass flow through plane y-z at  $(x, y, z)$

$$q_x \rho \, dy \, dz \, L/T \quad M/L^3 \, L \, L = M/T$$

Rate of change of mass flux in the x-direction per unit time per cross-section is

$$\frac{\partial}{\partial x} [\rho q_x] \, dy \, dz$$

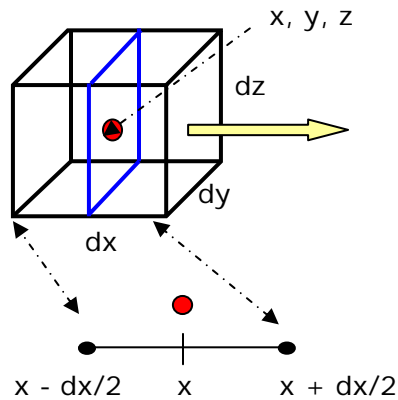

mass flow into the entry plane y-z is

$$[\rho q_x]dydz - \frac{\partial}{\partial x}[\rho q_x] \frac{dx}{2} dydz$$

And mass flow out of the exit plane y-z is

$$[\rho q_x]dydz + \frac{\partial}{\partial x}[\rho q_x] \frac{dx}{2} dydz$$

In the x-direction, the flow in minus the flow out is

$$-\frac{\partial}{\partial x}[\rho q_x]dxdydz$$

Similarly, the flow in the y-direction through the plane dx dz (figure on left)

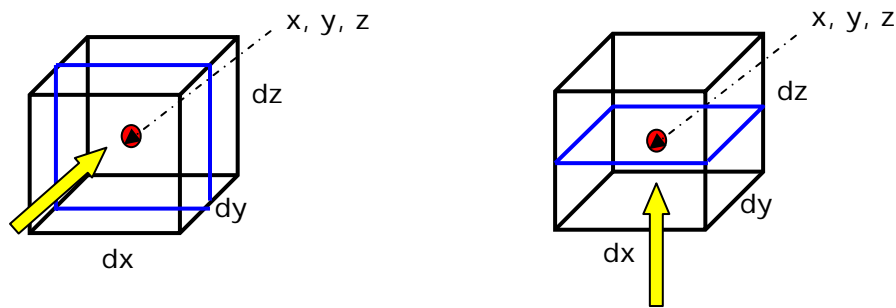

$$\left[ [\rho q_y]dxdz - \frac{\partial}{\partial y}[\rho q_y] \frac{dy}{2} dxdz \right] - \left[ [\rho q_y]dxdz + \frac{\partial}{\partial y}[\rho q_y] \frac{dy}{2} dxdz \right] = -\frac{\partial}{\partial y}[\rho q_y]dxdydz$$

for the net y-mass flux.

Similarly, we get for the net mass flux in the z-direction:

$$-\frac{\partial}{\partial z}[\rho q_z]dxdydz$$

The **total mass flux** (flow out of the box) is

$$\left[ -\frac{\partial[\rho q_x]}{\partial x} - \frac{\partial[\rho q_y]}{\partial y} - \frac{\partial[\rho q_z]}{\partial z} \right] dxdydz$$

Let's consider time derivative = 0 (Steady State System)

$$-\left[ \frac{\partial[\rho q_x]}{\partial x} + \frac{\partial[\rho q_y]}{\partial y} + \frac{\partial[\rho q_z]}{\partial z} \right] dx dy dz = \frac{\partial M}{\partial t} = 0$$

How does Darcy's Law fit into this?

$$q_x = -K_{xx} \frac{\partial h}{\partial x} \quad q_y = -K_{yy} \frac{\partial h}{\partial y} \quad q_z = -K_{zz} \frac{\partial h}{\partial z}$$

- For anisotropy (with alignment of coordinate axes and tensor principal directions), or  $\vec{q} = -K\nabla h$
- Assuming constant density for groundwater

$$0 = -\rho \left[ \frac{\partial[q_x]}{\partial x} + \frac{\partial[q_y]}{\partial y} + \frac{\partial[q_z]}{\partial z} \right] \text{ substituting for } q,$$

$$0 = (-)(-)\rho \left[ \frac{\partial}{\partial x} \left( K_x \frac{\partial h}{\partial x} \right) + \frac{\partial}{\partial y} \left( K_y \frac{\partial h}{\partial y} \right) + \frac{\partial}{\partial z} \left( K_z \frac{\partial h}{\partial z} \right) \right]$$

Steady-state flow equation for heterogeneous, anisotropic conditions:

$$0 = \left[ \frac{\partial}{\partial x} \left( K_x \frac{\partial h}{\partial x} \right) + \frac{\partial}{\partial y} \left( K_y \frac{\partial h}{\partial y} \right) + \frac{\partial}{\partial z} \left( K_z \frac{\partial h}{\partial z} \right) \right]$$

For isotropic, homogeneous conditions (K is not directional)

$$0 = K \left[ \frac{\partial^2 h}{\partial x^2} + \frac{\partial^2 h}{\partial y^2} + \frac{\partial^2 h}{\partial z^2} \right]$$

This is the "diffusion equation" or "heat-flow equation"

For **Steady State** (K cancels)  $0 = \left[ \frac{\partial^2 h}{\partial x^2} + \frac{\partial^2 h}{\partial y^2} + \frac{\partial^2 h}{\partial z^2} \right]$

This is called the **Laplace equation**.

$\nabla^2$  is the "Laplacian" operator.

$$\nabla^2 = \frac{\partial^2 \cdot}{\partial x^2} + \frac{\partial^2 \cdot}{\partial y^2} + \frac{\partial^2 \cdot}{\partial z^2} \text{ giving } = \nabla^2 h$$

Note that the full equation at this point can be written in summation notation as:

$$0 = \frac{\partial}{\partial x_i} (K_{ij}) \frac{\partial h}{\partial x_j}$$

$$\begin{matrix} K_{11} & K_{12} & K_{13} \\ K_{21} & K_{22} & K_{23} \\ K_{31} & K_{32} & K_{33} \end{matrix} = \begin{matrix} K_{xx} & K_{xy} & K_{xz} \\ K_{yx} & K_{yy} & K_{yz} \\ K_{zx} & K_{zy} & K_{zz} \end{matrix}$$

The first Equation (flow in the x direction) is:

$$\frac{\partial}{\partial x} K_{xx} \frac{\partial h}{\partial x} + \frac{\partial}{\partial x} K_{xy} \frac{\partial h}{\partial y} + \frac{\partial}{\partial x} K_{xz} \frac{\partial h}{\partial z} \quad \text{or}$$

$$\frac{\partial}{\partial x_1} K_{11} \frac{\partial h}{\partial x_1} + \frac{\partial}{\partial x_1} K_{12} \frac{\partial h}{\partial x_2} + \frac{\partial}{\partial x_1} K_{13} \frac{\partial h}{\partial x_3}$$

What is the head distribution in a SS homogeneous system? Consider solution to steady-state problem (1-Dimensional) 1D Confined Aquifer – Head Distribution

$$K(x=0) = H_0 \quad \text{and} \quad h(x=L) = 0$$

$$1) \quad 0 = \left[ \frac{\partial^2 h}{\partial x^2} \right] \rightarrow 0 = \frac{\partial^2 h}{\partial x^2}$$

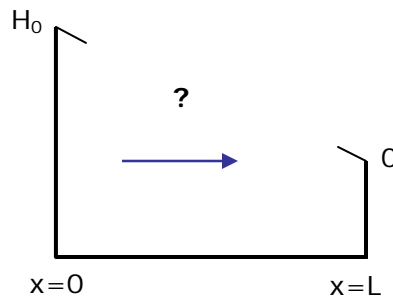

Steady h distribution not f(K) – **h is independent of K.**

## Flow Nets

As we have seen, to work with the groundwater flow equation in any meaningful way, we have to find some kind of a *solution* to the equation. This solution is based on *boundary conditions*, and in the transient case, on *initial conditions*.

Let us look at the two-dimensional, steady-state case. In other words, let the following equation apply:

$$0 = \frac{\partial}{\partial x} \left( K_x \frac{\partial h}{\partial x} \right) + \frac{\partial}{\partial y} \left( K_y \frac{\partial h}{\partial y} \right) \quad (\text{Map View})$$

A solution to this equation requires us to specify boundary condition. For our purposes with flow nets, let us consider

- No-flow boundaries ( $\frac{\partial h}{\partial n} = 0$ , where  $n$  is the direction perpendicular to the boundary).
- Constant-head boundaries ( $h = \text{constant}$ )
- Water-table boundary (free surface,  $h$  is not a constant)

A relatively straightforward graphical technique can be used to find the solution to the GW flow equation for many such situations. This technique involves the construction of a **flow net**.

A flow net is the set of equipotential lines (constant head) and the associated flow lines (lines along which groundwater moves) for a particular set of boundary conditions.

- For a given GW flow equation and a given value of  $K$ , the boundary conditions completely determine the solution, and therefore a flow net.

In addition, let us *first* consider only homogeneous, isotropic conditions:

$$0 = \frac{\partial^2 h}{\partial x^2} + \frac{\partial^2 h}{\partial z^2} \quad (\text{Cross-Section})$$

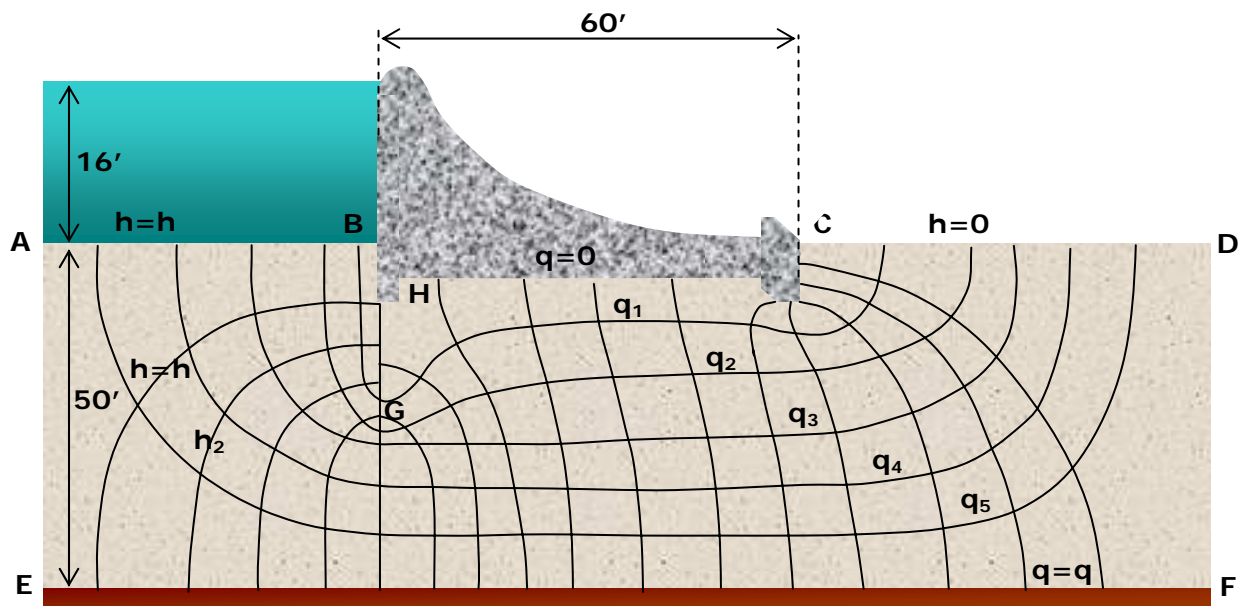
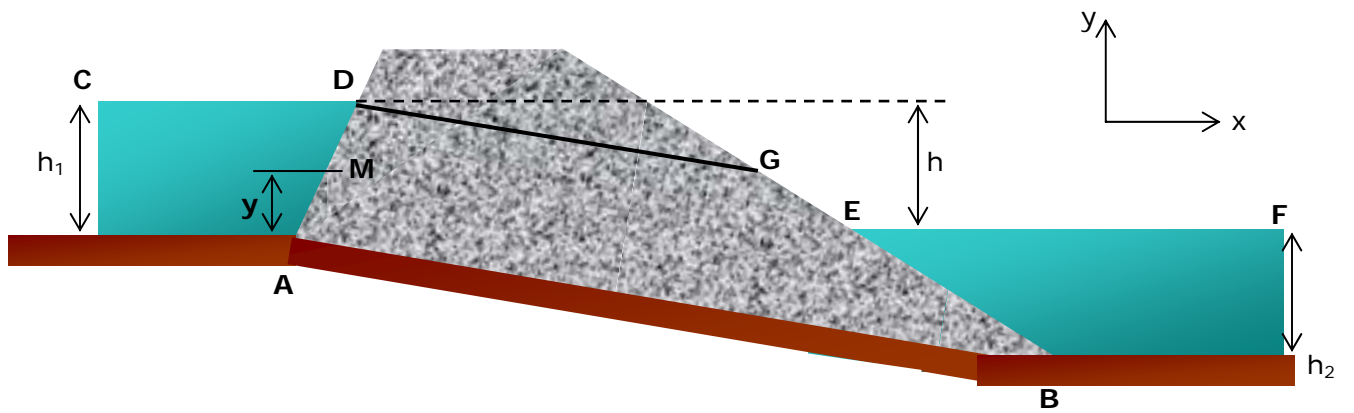
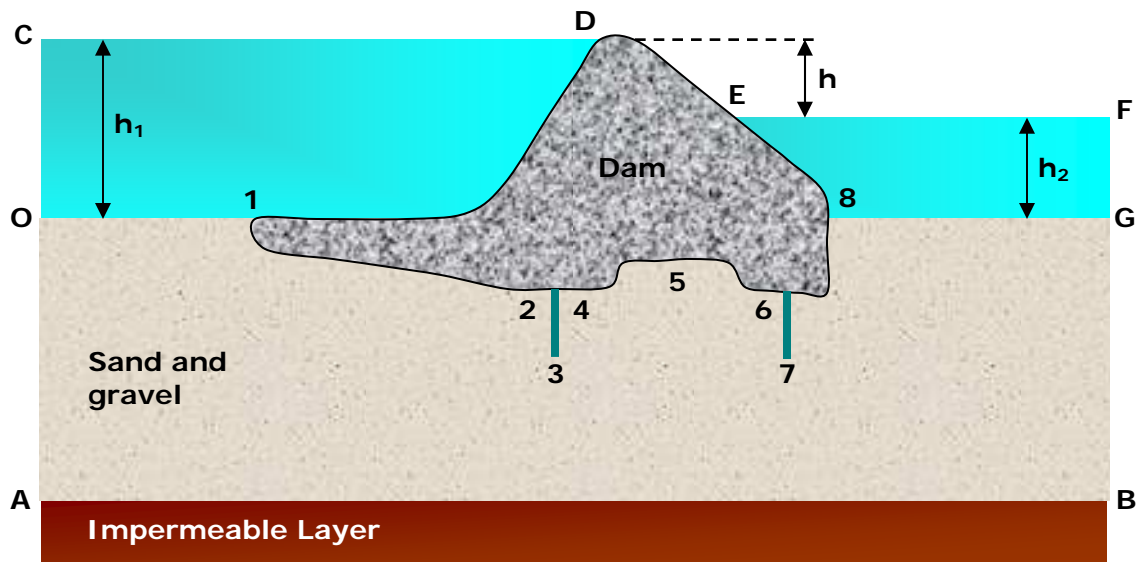

Let's look at flow in the vicinity of each of these boundaries. (Isotropic, homogeneous conditions).

**No-Flow Boundaries:**  $\frac{\partial h}{\partial x} = 0$  or  $\frac{\partial h}{\partial y} = 0$  or  $\frac{\partial h}{\partial n} = 0$

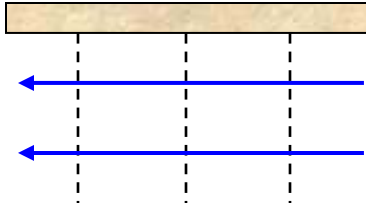

- Flow is parallel to the boundary.
- Equipotentials are perpendicular to the boundary

**Constant-Head Boundaries:**  $h = \text{constant}$

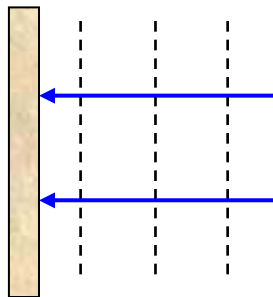

- Flow is perpendicular to the boundary.
- Equipotentials are parallel to the boundary.

**Water Table Boundaries:**  $h = z$

Anywhere in an aquifer, total head is pressure head plus elevation head:

$$h = \psi + z$$

However, at the water table,  $\psi = 0$ . Therefore,  $h = z$

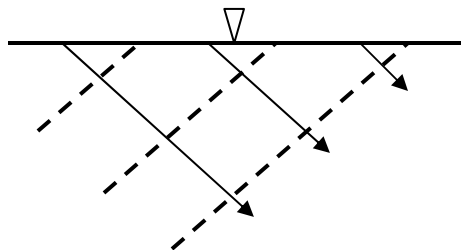

Neither flow nor equipotentials are necessarily perpendicular to the boundary.

**Rules for Flow Nets (Isotropic, Homogeneous System):**

In addition to the boundary conditions the following rules must apply in a flow net:

- 1) Flow is perpendicular to equipotentials *everywhere*.
- 2) Flow lines never intersect.
- 3) The areas between flow lines and equipotentials are “curvilinear squares”. In other words, the central dimensions of the “squares” are the same (but the flow lines or equipotentials can curve).
  - If you draw a circle inside the curvilinear square, it is tangential to all four sides at some point.

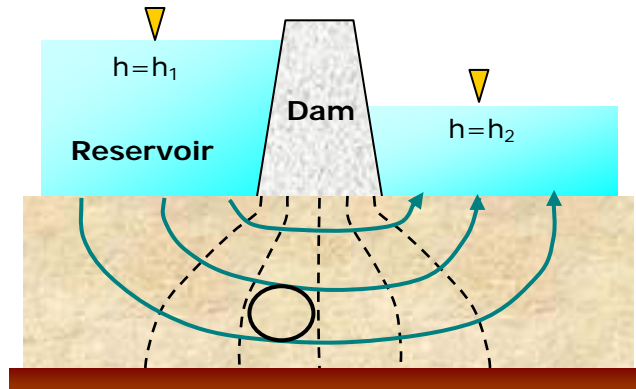

Why are these circles? It preserves  $dQ$  along any stream tube.

$$dQ = K dm; dh/ds = K dh$$

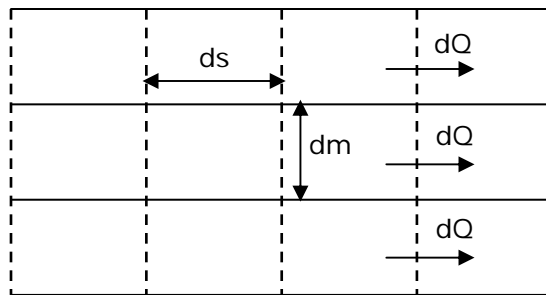

If  $dm \neq ds$  (i.e. ellipse, not circle), then a constant factor is used.

**Other points:**

It is not necessary that flow nets have finite boundaries on all sides; regions of flow that extend to infinity in one or more directions are possible (e.g., see the figure above).

A flow net can have “partial” stream tubes along the edge. A flow net can have partial squares at the edges or ends of the flow system.

**Calculations from Flow Nets:**

It is possible to make many good, quantitative predictions from flow nets. In fact, at one time flow nets were the major tool used for solving the GW flow equation.



Probably the most important calculation is discharge from the system. For a system with one recharge area and one discharge area, we can calculate the discharge with the following expression:

$$Q = n_f K dH \quad H = n_d dH$$

Gives:  $Q = n_f/n_d KH$

Where  $Q$  is the volume discharge rate *per unit thickness of section* perpendicular to the flow net;  $n_f$  is the number of stream tubes (or flow channels);  $n_d$  is the number of head drops;  $K$  is the uniform hydraulic conductivity; and  $H$  is the total head drop over the region of flow.

- Note that neither  $n_f$  nor  $n_d$  is necessarily an integer, but it is often helpful if you construct the flow net such that one of them is an integer.
- If you choose  $n_f$  as an integer, it is unlikely that  $n_d$  will be an integer.
- Note that to do this calculation, you do not need to know any lengths.

### Flow Nets in Anisotropic, Homogeneous Systems:

Before construction of a flow net in an anisotropic system ( $K_x \neq K_y$  or  $K_x \neq K_z$  etc.), we have to *transform* the system.

$$\frac{\partial}{\partial x} \left( K_x \frac{\partial h}{\partial x} \right) + \frac{\partial}{\partial z} \left( K_z \frac{\partial h}{\partial z} \right) = 0$$

For homogeneous  $K$ ,

$$\frac{\partial^2 h}{\partial x^2} + \frac{K_z}{K_x} \frac{\partial^2 h}{\partial z^2} = 0$$

Introduce the transformed variable

$$Z = \sqrt{\frac{K_x}{K_z}} z$$

Applying this variable gives:

$$\frac{\partial^2 h}{\partial x^2} + \frac{\partial^2 h}{\partial Z^2} = 0$$

With this equation we can apply flownets exactly as we did before. We just have to remember how  $Z$  relates to the actual dimension  $z$ .

In an anisotropic medium, perform the following steps in constructing a flow net:

1. Transform the system (the area where a flow net is desired) by the following ratio:

$$Z = Z' \sqrt{\frac{K_z}{K_x}}$$

where  $z$  is the original vertical dimension of the system (on your page, in cm, inches, etc.) and  $Z'$  is the transformed vertical dimension.

$K_x$  is the hydraulic conductivity horizontally on your page, and  $K_z$  is the hydraulic conductivity vertically on your page. This transformation is not specific to the x-dimension or the y-dimension.

2. On the transformed system, follow the exact same principles for flow nets as outlined for a homogeneous, isotropic system.
3. Perform the inverse transform on the system, i.e.

$$Z = Z' \sqrt{\frac{K_z}{K_x}}$$

4. If any flow calculations are needed, do these calculations on the homogeneous (step 2) section. Use the following for hydraulic conductivity:

$$K' = \sqrt{K_x K_z}$$

Where  $K'$  is the homogeneous hydraulic conductivity of the transformed section. (NOTE: This transformed  $K'$  is not real! It is only used for calculations on the transformed section.)

**Examples:**

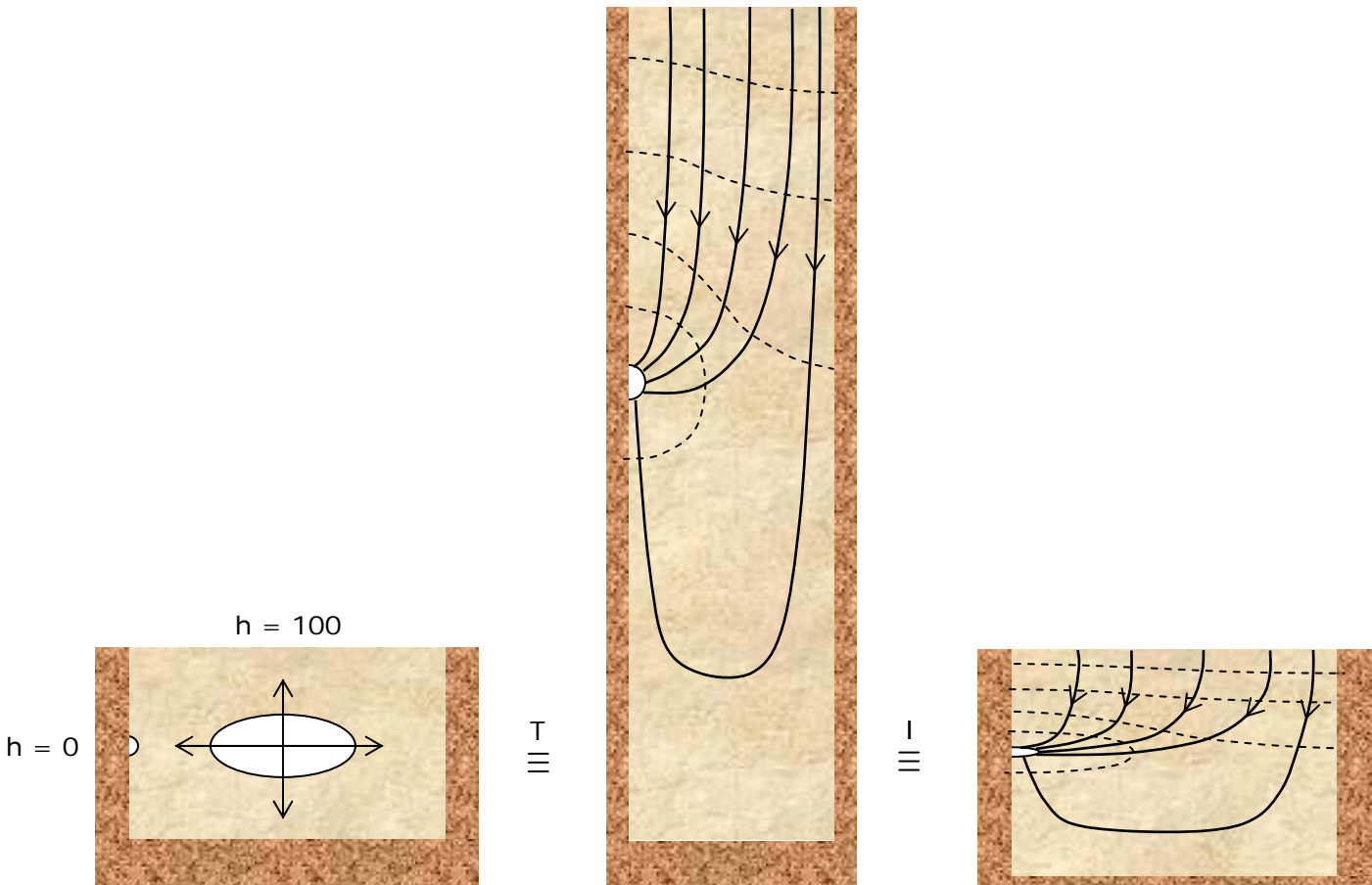

## Flow Nets in Heterogeneous Systems:

We will only deal with construction of flow nets in the simplest types of heterogeneous systems. We will restrict ourselves to **layered heterogeneity**.

In a layered system, the same rules apply as in a homogeneous system, with the following important exceptions:

1. Curvilinear squares can only be drawn in ONE layer. In other words, in a two-layer system, you will only have curvilinear squares in one of the layers. Which layer to draw squares in is your choice: in general you should choose the thicker/larger layer.
2. At boundaries between layers, flow lines are refracted (in a similar way to the way light is refracted between two different media). The relationship between the angles in two layers is given by the "tangent law":

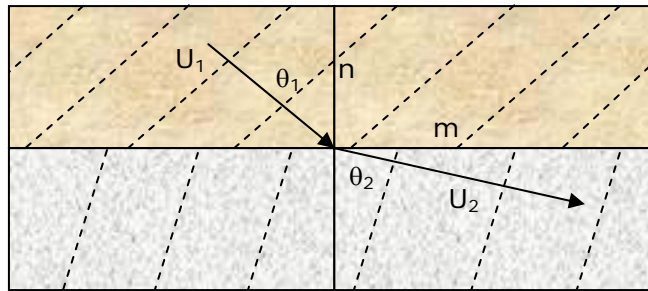

$$h_1 = h_2 \rightarrow \frac{\partial h_1}{\partial m} = \frac{\partial h_2}{\partial m} \quad (1) \text{ No sudden head changes}$$

$$K_1 \frac{\partial h_1}{\partial n} = K_2 \frac{\partial h_2}{\partial n} \quad (2) \text{ Conservation of Mass}$$

<u>Layer 1</u>	<u>Layer 2</u>
$u_x: U_1 \sin \theta_1 = -K_1 \frac{\partial h_1}{\partial m}$	$U_2 \sin \theta_2 = -K_2 \frac{\partial h_2}{\partial m}$
$u_y: U_1 \cos \theta_1 = -K_1 \frac{\partial h_1}{\partial n}$	$U_2 \cos \theta_2 = -K_2 \frac{\partial h_2}{\partial n}$

$$\text{By (1): } \frac{U_1 \sin \theta_1}{K_1} = \frac{U_2 \sin \theta_2}{K_2}$$

$$\text{By (2): } U_1 \cos \theta_1 = U_2 \cos \theta_2$$

$$\frac{K_1}{K_2} = \frac{\tan \theta_1}{\tan \theta_2}$$

You can rearrange the tangent law in any way to determine one unknown quantity. For example, to determine the angle  $\theta_2$ :

$$\theta_2 = \tan^{-1}\left(\frac{K_2}{K_1} \tan \theta_1\right)$$

One important consequence for a medium with large contrasts in K: high-K layers will often have almost horizontal flow (in general), while low-K layers will often have almost vertical flow (in general).

**Example:**

In a three-layer system,  $K_1 = 1 \times 10^{-3}$  m/s and  $K_2 = 1 \times 10^{-4}$  m/s.  $K_3 = K_1$ . Flow in the system is  $14^\circ$  below horizontal. What do flow in layers 2 and 3 look like?

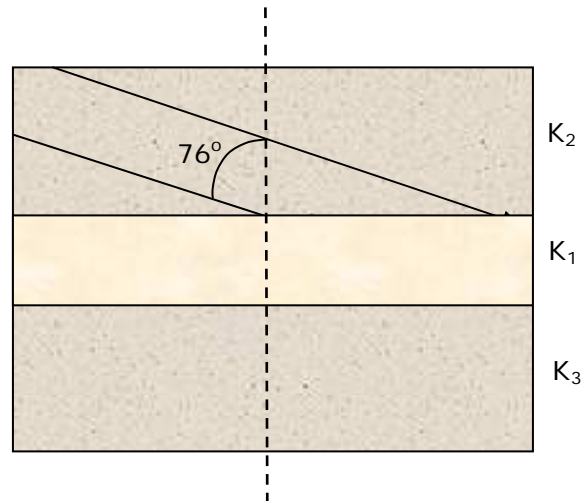

$$\theta_2 = \tan^{-1}\left(\frac{1 \times 10^{-4}}{1 \times 10^{-3}} \tan 76^\circ\right) = 22^\circ$$

What is the angle in layer 3? If you do the calculation, you will find it is  $76^\circ$  again.

When drawing flow nets with different layers, a very helpful question to ask is “What layer allows water to go from the entrance point to the exit point the easiest?” Or, in other words, “What is the easiest (frictionally speaking) way for water to go from here to there?”

